

Panasonic
ideas for life

**High capacity
PhotoMOS Relay.
(Load current Max. 4A)
DC load type is available.**

**Power PhotoMOS
(AQZ100, 200)**

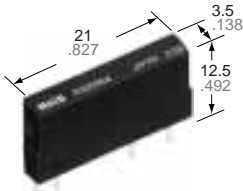

mm inch

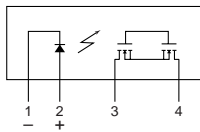

AC/DC type

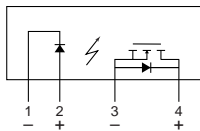

DC type

FEATURES

1. High capacity PhotoMOS Relay in a compact and slim 4-pin SIL
2. Extremely low ON resistance
3. Control low-level signal
Power Photo MOS relays feature extremely low closed-circuit offset voltage to enable control of low-level analog signals without distortion.
4. Low-level off state leakage current
5. High I/O isolation voltage 2,500 V
6. Eliminates the need for a counter electromotive protection diode in the drive circuit on the input side
7. Eliminate the need for a power supply to drive the power MOSFET
8. PC board layout is simplified
9. No restriction on mounting direction
10. Varistor incorporated type is also available.

TYPICAL APPLICATIONS

- High-speed inspection machines
- IC checker
- NC machine, Robots
- Of ce machines
- Telecommunication
- Automotive

TYPES

1. AC/DC type

Output rating		Part No.	Packing quantity	
Load voltage	Load current		Inner carton	Outer carton
60 V	3.0 A	AQZ202	25 pcs.	500 pcs.
100 V	2.0 A	AQZ205		
200 V	1.0 A	AQZ207		
400 V	0.5 A	AQZ204		

2. DC type

Output rating		Part No.	Packing quantity	
Load voltage	Load current		Inner carton	Outer carton
60 V	4.0 A	AQZ102	25 pcs.	500 pcs.
100 V	2.6 A	AQZ105		
200 V	1.3 A	AQZ107		
400 V	0.7 A	AQZ104		

Notes: Load voltage and current of AC/DC type: Peak AC/DC.
Load voltage and current of DC type: DC

RATING

1. AC/DC type

1) Absolute maximum ratings (Ambient temperature: 25°C 77°F)

Item		Symbol	AQZ202	AQZ205	AQZ207	AQZ204	Remarks
Input	LED forward current	I_F	50 mA				
	LED reverse voltage	V_R	5 V				
	Peak forward current	I_{FP}	1 A				f = 100 Hz, Duty factor = 0.1%
	Power dissipation	P_{in}	75 mW				
Output	Load voltage (Peak AC)	V_L	60 V	100 V	200 V	400 V	
	Continuous load current	I_L	3.0 A	2.0 A	1.0 A	0.5 A	
	Peak load current	I_{peak}	9.0 A	6.0 A	3.0 A	1.5 A	100 ms (1 shot), $V_L = DC$
	Power dissipation	P_{out}	1.6 W				
Total power dissipation		P_T	1.6 W				
I/O isolation voltage		V_{iso}	2,500 V AC				
Temperature limits	Operating	T_{opr}	-40°C to +85°C -40°F to +185°F				Non-condensing at low temperatures
	Storage	T_{stg}	-40°C to +100°C -40°F to +212°F				

2) Electrical characteristics (Ambient temperature: 25°C 77°F)

Item			Symbol	AQZ202	AQZ205	AQZ207	AQZ204	Condition	
Input	LED operate current	Typical	I_{Fon}	1.0 mA				$I_L = 100\text{ mA}$ $V_L = 10\text{ V}$	
		Maximum		3.0 mA					
	LED turn off current	Minimum	I_{Foff}	0.4 mA				$I_L = 100\text{ mA}$ $V_L = 10\text{ V}$	
		Typical		0.9 mA					
LED dropout voltage	Typical	V_F	1.25 V (1.16 V at $I_F = 10\text{ mA}$)				$I_F = 50\text{ mA}$		
	Maximum		1.5 V						
Output	On resistance	Typical	R_{on}	0.11 Ω	0.23 Ω	0.7 Ω	2.1 Ω	$I_F = 10\text{ mA}$ $I_L = \text{Max.}$ Within 1 s on time	
		Maximum		0.18 Ω	0.34 Ω	1.1 Ω	3.2 Ω		
	Off state leakage current	Maximum	—	10 μA				$I_F = 0\text{ mA}$ $V_L = \text{Max.}$	
Transfer characteristics	Switching speed	Turn on time*	T_{on}	Typical	2.46 ms	2.40 ms	1.12 ms	1.65 ms	$I_F = 10\text{ mA}$ $I_L = 100\text{ mA}$ $V_L = 10\text{ V}$
				Maximum	5.0 ms				
		Typical		5.64 ms	5.65 ms	2.57 ms	3.88 ms	$I_F = 5\text{ mA}$ $I_L = 100\text{ mA}$ $V_L = 10\text{ V}$	
		Maximum		10.0 ms					
	Turn off time*	Typical	T_{off}	0.22 ms	0.21 ms	0.10 ms	0.08 ms	$I_F = 5\text{ mA or } 10\text{ mA}$ $I_L = 100\text{ mA}$ $V_L = 10\text{ V}$	
		Maximum		3.0 ms					
	I/O capacitance	Typical	C_{iso}	0.8 pF				f = 1 MHz $V_B = 0\text{ V}$	
		Maximum		1.5 pF					
Initial I/O isolation resistance	Minimum	R_{iso}	1,000 M Ω				500 V DC		
Maximum operating speed	Maximum	—	0.5 cps				$I_F = 10\text{ mA}$ Duty factor = 50% $I_L = \text{Max.}, V_L = \text{Max.}$		
Vibration resistance		Minimum	—	10 to 55 Hz at double amplitude of 3 mm				2 hours for 3 axes	
Shock resistance		Minimum	—	4,900 m/s ² {500 G} 1 ms				3 times for 3 axes	

Note: Recommendable LED forward current $I_F = 5$ to 10 mA.

*Turn on/off time

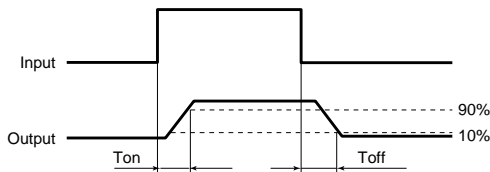

Power PhotoMOS (AQZ100, 200)

2. DC type

1) Absolute maximum ratings (Ambient temperature: 25°C 77°F)

Item		Symbol	AQZ102	AQZ105	AQZ107	AQZ104	Remarks
Input	LED forward current	I_F	50 mA				
	LED reverse voltage	V_R	5 V				
	Peak forward current	I_{FP}	1 A				f = 100 Hz, Duty factor = 0.1%
	Power dissipation	P_{in}	75 mW				
Output	Load voltage (DC)	V_L	60 V	100 V	200 V	400 V	
	Continuous load current (DC)	I_L	4.0 A	2.6 A	1.3 A	0.7 A	
	Peak load current	I_{peak}	9.0 A	6.0 A	3.0 A	1.5 A	100 ms (1 shot), $V_L = DC$
	Power dissipation	P_{out}	1.35 W				
Total power dissipation		P_T	1.35 W				
I/O isolation voltage		V_{iso}	2,500 V AC				
Temperature limits	Operating	T_{opr}	-40°C to +85°C -40°F to +185°F				Non-condensing at low temperatures
	Storage	T_{stg}	-40°C to +100°C -40°F to +212°F				

2) Electrical characteristics (Ambient temperature: 25°C 77°F)

Item			Symbol	AQZ102	AQZ105	AQZ107	AQZ104	Condition		
Input	LED operate current	Typical	I_{Fon}	1.0 mA				$I_L = 100 mA$ $V_L = 10 V$		
		Maximum		3.0 mA						
	LED turn off current	Minimum	I_{Foff}	0.4 mA				$I_L = 100 mA$ $V_L = 10 V$		
		Typical		0.9 mA						
	LED dropout voltage	Typical	V_F	1.25 V (1.16 V at $I_F = 10 mA$)				$I_F = 50 mA$		
		Maximum		1.5 V						
Output	On resistance	Typical	R_{on}	0.05 Ω	0.081 Ω	0.34 Ω	1.06 Ω	$I_F = 10 mA$ $I_L = Max.$ Within 1 s on time		
		Maximum		0.09 Ω	0.17 Ω	0.55 Ω	1.6 Ω			
	Off state leakage current	Maximum	—	10 μA				$I_F = 0 mA$ $V_L = Max.$		
Transfer characteristics	Switching speed	Turn on time*	T_{on}	Typical	1.66 ms	1.89 ms	0.83 ms	1.01 ms	$I_F = 10 mA$ $I_L = 100 mA$ $V_L = 10 V$	
				Maximum	5.0 ms					
		Turn off time*		Typical	T_{off}	3.79 ms	4.50 ms	1.75 ms	2.34 ms	$I_F = 5 mA$ $I_L = 100 mA$ $V_L = 10 V$
				Maximum		10.0 ms				
	I/O capacitance	Typical	C_{iso}	0.8 pF				f = 1 MHz $V_B = 0 V$		
		Maximum		1.5 pF						
	Initial I/O isolation resistance	Minimum	R_{iso}	1,000 M Ω				500 V DC		
	Maximum operating speed	Maximum	—	0.5 cps				$I_F = 10 mA$ Duty factor = 50% $I_L \times V_L = 200 (VA)$		
	Vibration resistance		Minimum	—	10 to 55 Hz at double amplitude of 3 mm				2 hours for 3 axes	
	Shock resistance		Minimum	—	4,900 m/s ² {500 G} 1 ms				3 times for 3 axes	

Note: Recommendable LED forward current $I_F = 5$ to 10 mA.

*Turn on/off time

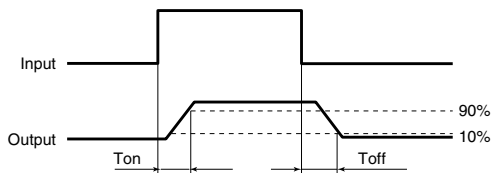

REFERENCE DATA

1.-(1) Load current vs. ambient temperature characteristics (AC/DC type)

Allowable ambient temperature: -40°C to $+85^{\circ}\text{C}$
 -40°F to $+185^{\circ}\text{F}$

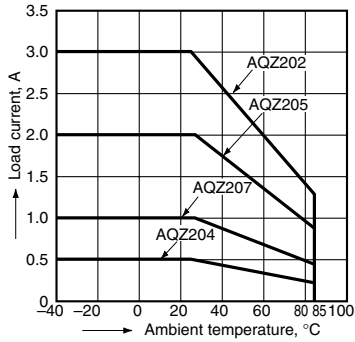

1.-(2) Load current vs. ambient temperature characteristics (DC type)

Allowable ambient temperature: -40°C to $+85^{\circ}\text{C}$
 -40°F to $+185^{\circ}\text{F}$

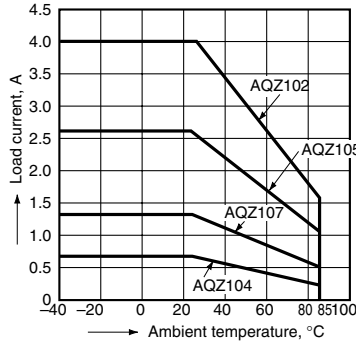

2. Load current vs. ambient temperature characteristics in adjacent mounting

I_L : Load current;
 $I_L(\text{max.})$: Maximum continuous load current

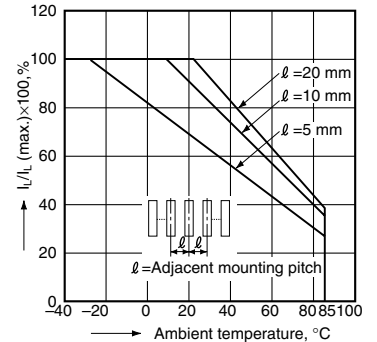

3.-(1) On resistance vs. ambient temperature characteristics

LED current: 10 mA;

Continuous load current: 1.2 A (DC) (AQZ202),
 0.8 A (DC) (AQZ205),
 1.6 A (DC) (AQZ102),
 1.04 A (DC) (AQZ105)

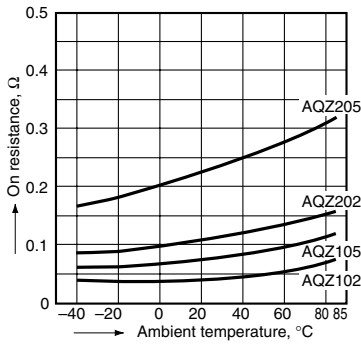

3.-(2) On resistance vs. ambient temperature characteristics

LED current: 10 mA;

Continuous load current: 0.4 A (DC) (AQZ207),
 0.2 A (DC) (AQZ204),
 0.52 A (DC) (AQZ107),
 0.28 A (DC) (AQZ104)

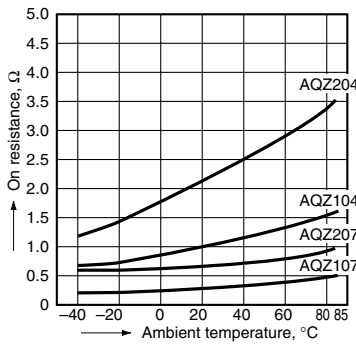

4.-(1) Turn on time vs. ambient temperature characteristics (AC/DC type)

LED current: 10 mA;

Load voltage: 10 V (DC);
 Continuous load current: 100 mA (DC)

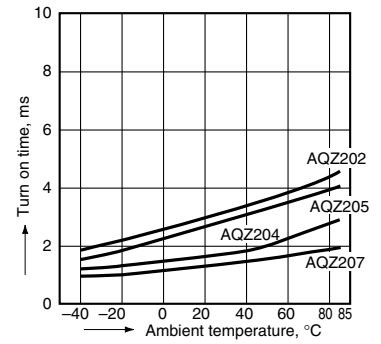

4.-(2) Turn on time vs. ambient temperature characteristics (DC type)

LED current: 10 mA;

Load voltage: 10 V (DC);
 Continuous load current: 100 mA (DC)

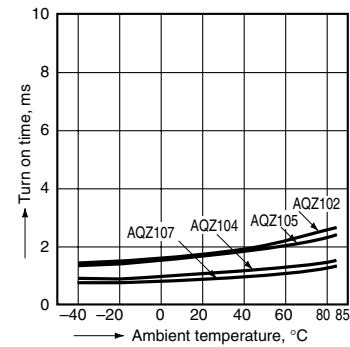

5.-(1) Turn off time vs. ambient temperature characteristics (AC/DC type)

LED current: 10 mA;

Load voltage: 10 V (DC);
 Continuous load current: 100 mA (DC)

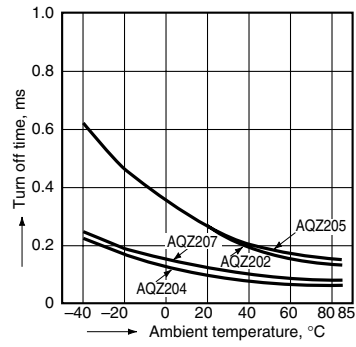

5.-(2) Turn off time vs. ambient temperature characteristics (DC type)

LED current: 10 mA;

Load voltage: 10 V (DC);
 Continuous load current: 100 mA (DC)

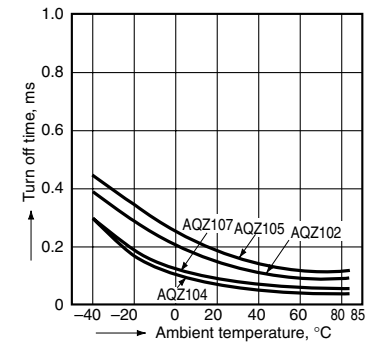

6.-(1) LED operate vs. ambient temperature characteristics (AC/DC type)

Load voltage: 10 V (DC);

Continuous load current: 100 mA (DC)

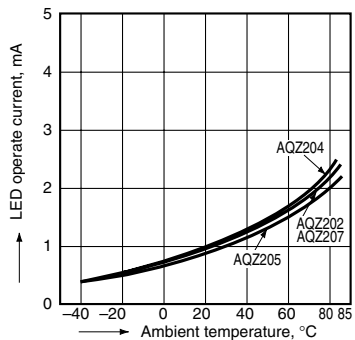

6.-(2) LED operate vs. ambient temperature characteristics (DC type)

Load voltage: 10 V (DC);

Continuous load current: 100 mA (DC)

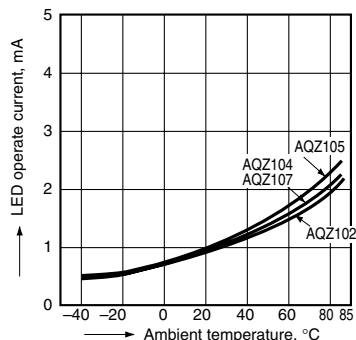

7.-(1) LED turn off current vs. ambient temperature characteristics (AC/DC type)

Load voltage: 10 V (DC);

Continuous load current: 100 mA (DC)

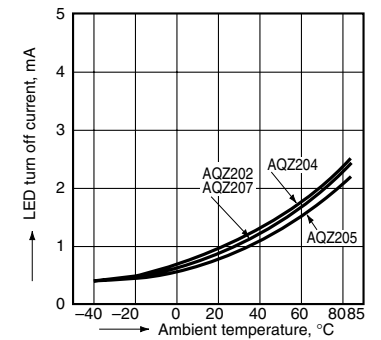

Power PhotoMOS (AQZ100, 200)

7.-(2) LED turn off current vs. ambient temperature characteristics (DC type)
Load voltage: 10 V (DC);
Continuous load current: 100 mA (DC)

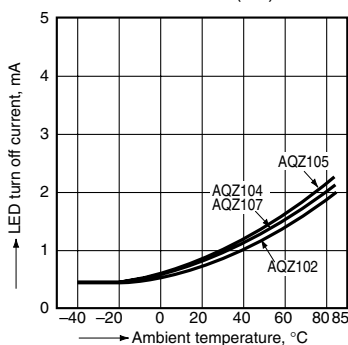

8. LED dropout voltage vs. ambient temperature characteristics
Sample: all types; LED current: 5 to 50 mA

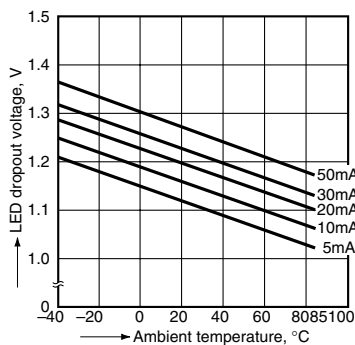

9.-(1) Current vs. voltage characteristics of output at MOS portion (AC/DC type)
Ambient temperature: 25°C 77°F

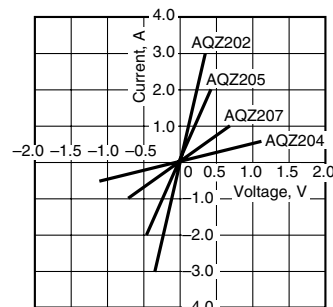

9.-(2) Current vs. voltage characteristics of output at MOS portion (DC type)
Ambient temperature: 25°C 77°F

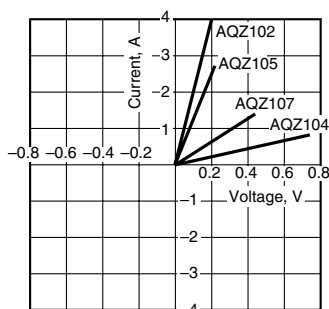

10. Off state leakage current vs. load voltage characteristics
Ambient temperature: 25°C 77°F

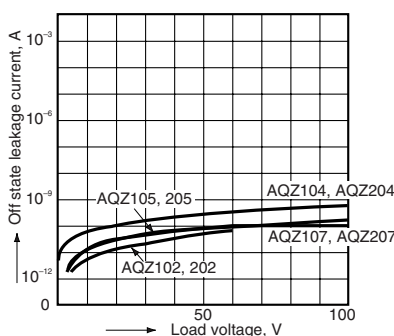

11.-(1) Turn on time vs. LED forward current characteristics (AC/DC type)
Load voltage: 10 V (DC);
Continuous load current: 100 mA (DC);
Ambient temperature: 25°C 77°F

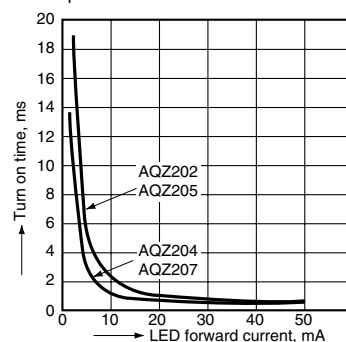

11.-(2) Turn on time vs. LED forward current characteristics (DC type)
Load voltage: 10 V (DC);
Continuous load current: 100 mA (DC);
Ambient temperature: 25°C 77°F

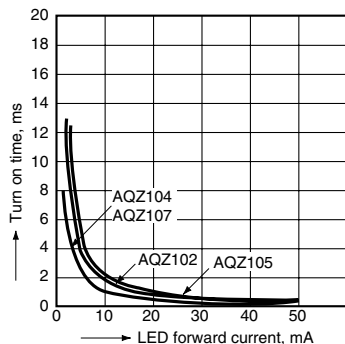

12.-(1) Turn off time vs. LED forward current characteristics (AC/DC type)
Load voltage: 10 V (DC);
Continuous load current: 100 mA (DC);
Ambient temperature: 25°C 77°F

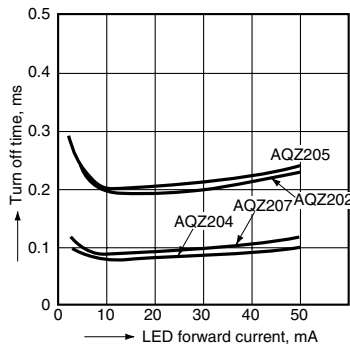

12.-(2) Turn off time vs. LED forward current characteristics (DC type)
Measured portion: between terminals 4 and 6;
Load voltage: 10 V (DC);
Continuous load current: 100 mA (DC);
Ambient temperature: 25°C 77°F

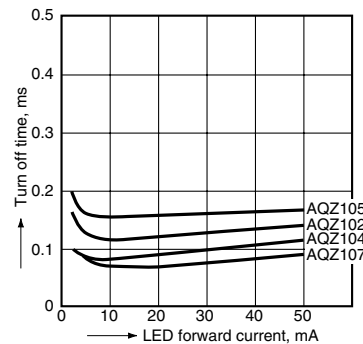

13.-(1) Turn on time vs. load voltage characteristics (Load voltage: 60, 100 V type)
LED current: 10 mA;
Continuous load current: 100 mA;
Ambient temperature: 25°C 77°F

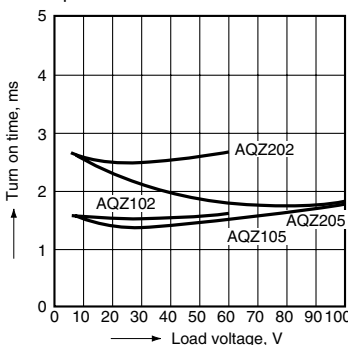

13.-(2) Turn on time vs. load voltage characteristics (Load voltage: 200, 400 V type)
LED current: 10 mA;
Continuous load current: 100 mA;
Ambient temperature: 25°C 77°F

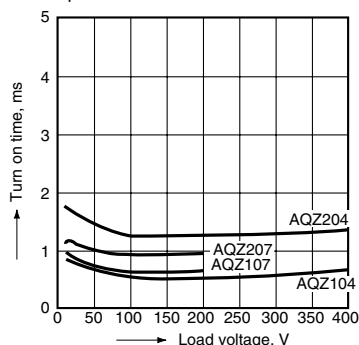

14.-(1) Turn on time vs. load current characteristics (Load voltage: 60, 100 V type)
LED current: 10 mA;
Load voltage: 10 V (DC);
Ambient temperature: 25°C 77°F

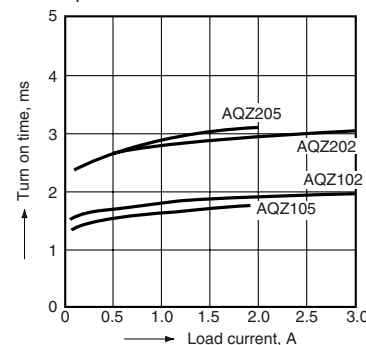

Power PhotoMOS (AQZ100, 200)

14.-(2) Turn on time vs. load current characteristics (Load voltage: 200, 400 V type)
LED current: 10 mA;
Load voltage: 10 V (DC);
Ambient temperature: 25°C 77°F

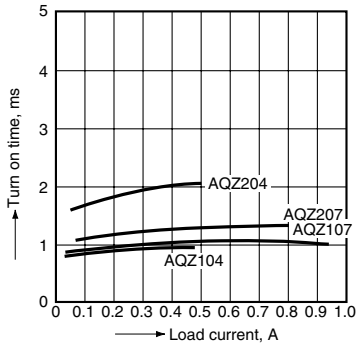

15.-(1) Turn off time vs. load voltage characteristics (Load voltage: 60, 100 V type)
LED current: 10 mA;
Continuous load current: 100 mA;
Ambient temperature: 25°C 77°F

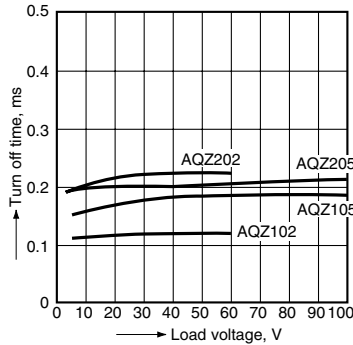

15.-(2) Turn off time vs. load voltage characteristics (Load voltage: 200, 400 V type)
LED current: 10 mA;
Continuous load current: 100 mA;
Ambient temperature: 25°C 77°F

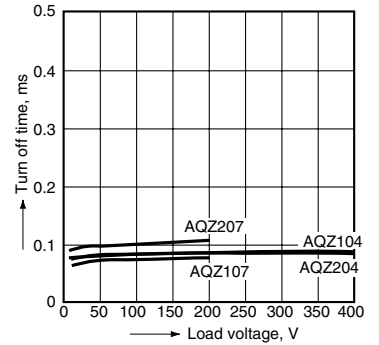

16.-(1) Turn off time vs. load current characteristics (Load voltage: 60, 100 V type)
LED current: 10 mA;
Load voltage: 10 V (DC);
Ambient temperature: 25°C 77°F

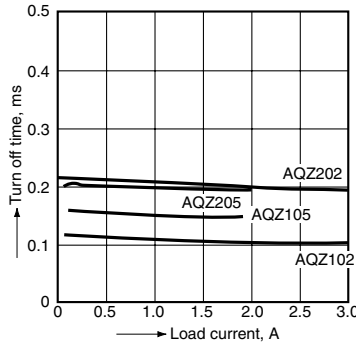

16.-(2) Turn off time vs. load current characteristics (Load voltage: 200, 400 V type)
LED current: 10 mA;
Load voltage: 10 V (DC);
Ambient temperature: 25°C 77°F

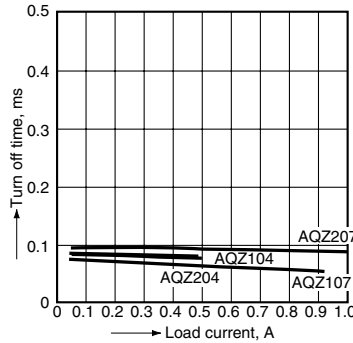

17. Maximum operating frequency vs. load voltage/current characteristics
LED current: 10 mA;
Ambient temperature: 25°C 77°F

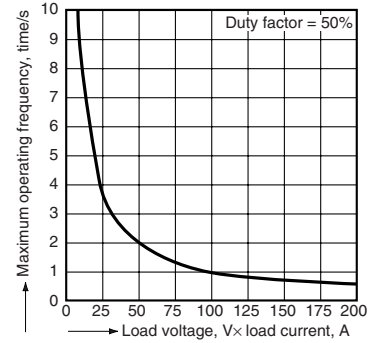

18.-(1) Output capacitance vs. applied voltage characteristics (AC/DC type)
Frequency: 1 MHz;
Ambient temperature: 25°C 77°F

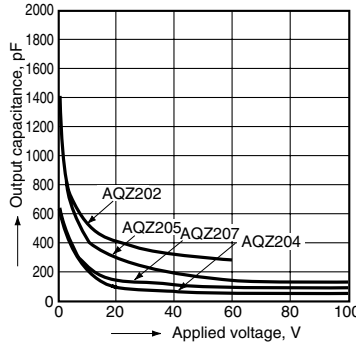

18.-(2) Output capacitance vs. applied voltage characteristics (DC type)
Frequency: 1 MHz;
Ambient temperature: 25°C 77°F

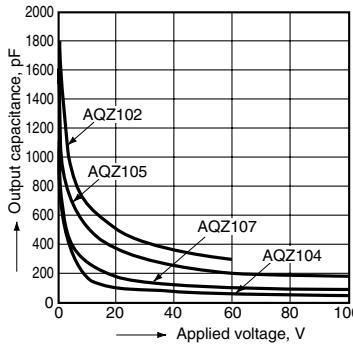

ACCESSORY

Socket

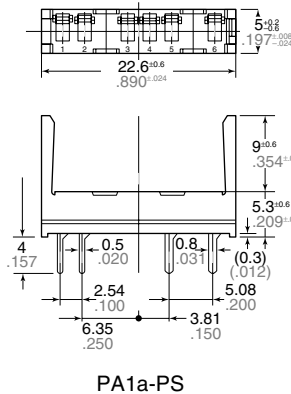

PA1a-PS

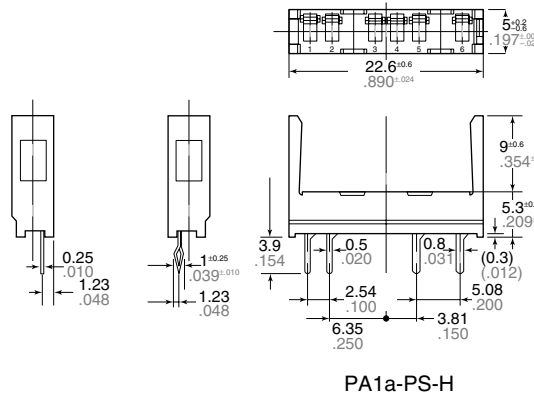

PA1a-PS-H

mm inch

PC board pattern (BOTTOM VIEW)

Standard type

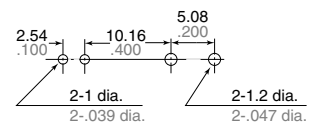

Self clinching type

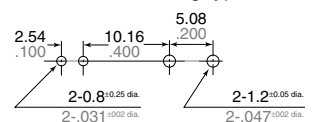

Tolerance: ±0.1 ±0.004